



What's in This Section

Standard and Custom Windows Page 3

- Parts Illustration 3**
- Unit Sizes 4**
 - Unit Sizes - Standard Windows 4
 - 100 Series Awning Warranty Label 5
- Sash 6**
 - Sash 6
 - Glazing Beads 7
 - Sash Weatherstrip 7
- Insect Screen 8**
 - Insect Screen 8
- Hardware 9**
 - Operators 9
 - Hinge Kits 9
 - Handle Parts 10
 - Lock Components 10
 - Fasteners 12
 - Hardware Parts 13
- Frames 14**
 - Frame Assembly 14
 - Frames 15
 - Frame Parts 15
- Joining Component 16**
 - Joining Components 16

Service Replacement Page 19

- Service Replacement Only Parts 19**
 - Trim Strip 19

100 Series Awning Windows (2008 to Present)

Standard and Custom Windows

Parts Illustration

Parts Illustration

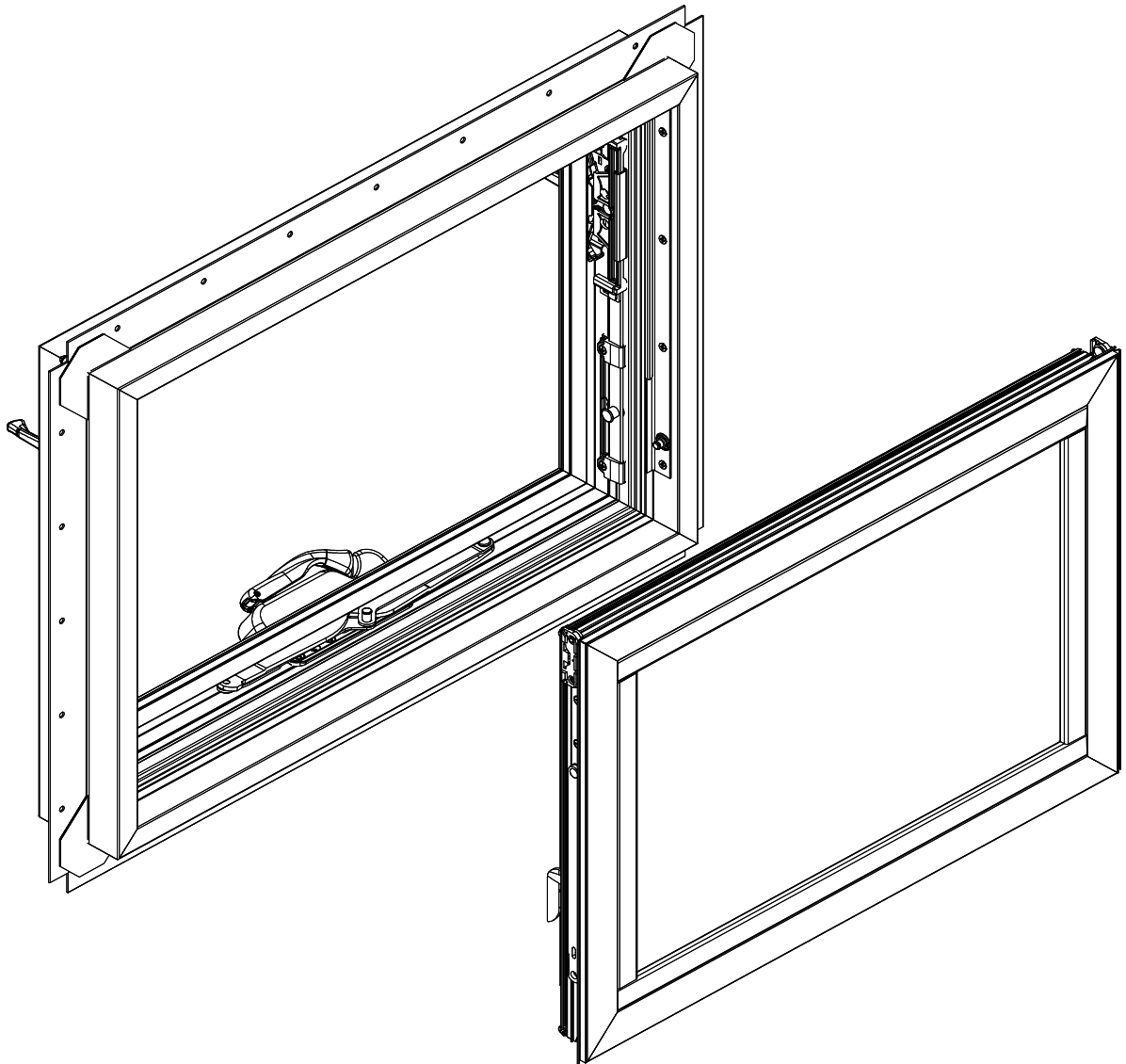

Manufactured 2008 to Present

100 Series Awning Window Unit Parts

Unit viewed from exterior.

Unit Sizes

Unit Sizes - Standard Windows

Note:

Unit Dimension refers to overall outside-to-outside frame. Unobstructed Glass refers to visible glass dimensions.

Awning - Single

Unit Dimension	1'-5 1/2" (445)	1'-11 1/2" (597)	2'-5 1/2" (749)	2'-11 1/2" (902)	3'-5 1/2" (1054)	3'-11 1/2" (1207)
Rough Opening	1'-6" (457)	2'-0" (610)	2'-6" (762)	3'-0" (914)	3'-6" (1067)	4'-0" (1219)
Unobstructed Glass*	11 1/4" (286)	1'-5 1/4" (438)	1'-11 1/4" (591)	2'-5 1/4" (743)	2'-11 1/4" (895)	3'-5 1/4" (1048)
1'-5 1/2"	(445) 1616	(597) 2016	(749) 2616	(902) 3016	(1054) 3616	(1207) 4016
1'-11 1/2"	(597) 1620	(610) 2020	(762) 2620	(914) 3020	(1067) 3620	(1219) 4020
2'-5 1/2"	(749) 1626	(762) 2026	(591) 2626	(914) 3026	(1067) 3626	(1219) 4026
2'-11 1/2"	(902) 1630	(914) 2030	(743) 2630	(914) 3030	(1067) 3630	(1219) 4030

Awning - Transom

Unit Dimension	2'-11 1/2" (902)	3'-5 1/2" (1054)	3'-11 1/2" (1207)	4'-5 1/2" (1359)	4'-11 1/2" (1511)	5'-5 1/2" (1664)	5'-11 1/2" (1816)
Rough Opening	3'-0" (914)	3'-6" (1067)	4'-0" (1219)	4'-6" (1372)	5'-0" (1524)	5'-6" (1676)	6'-0" (1829)
Unobstructed Glass*	11 1/2" (292)	1'-0" (292)	1'-6" (305)	1'-6" (305)	1'-6" (305)	1'-6" (305)	1'-6" (305)
1'-5 1/2"	(445) 1610-2	(597) 1910-2	(749) 2010-2	(902) 2310-2	(1054) 2610-2	(1207) 2910-2	(1359) 3010-2
1'-11 1/2"	(597) 1616-2	(610) 1916-2	(762) 2016-2	(914) 2316-2	(1067) 2616-2	(1219) 2916-2	(1372) 3016-2
2'-5 1/2"	(749) 1620-2	(762) 1920-2	(591) 2020-2	(914) 2320-2	(1067) 2620-2	(1219) 2920-2	(1372) 3020-2

Awning - Below Picture

3'-11 1/2" (1207)	4'-0" (1219)	2020	2620	3020	3620	4020
4'-11 1/2" (1511)	5'-0" (1524)	2026	2626	3026	3626	4026
5'-11 1/2" (1816)	6'-0" (1829)	2030	2630	3030	3630	4030
6'-11 1/2" (2121)	7'-0" (2134)	2040	2640	3040	3640	4040
7'-11 1/2" (2426)	8'-0" (2438)	2050	2650	3050	3650	4050

Awning - Double

1'-5 1/2" (445)	1'-6" (457)	1616-2	1916-2	2016-2	2316-2	2616-2	2916-2	3016-2
1'-11 1/2" (597)	2'-0" (610)	1620-2	1920-2	2020-2	2320-2	2620-2	2920-2	3020-2
2'-5 1/2" (749)	2'-6" (762)	1626-2	1926-2	2026-2	2326-2	2626-2	2926-2	3026-2
2'-11 1/2" (902)	3'-0" (914)	1630-2	1930-2	2030-2	2330-2	2630-2	2930-2	3030-2

Unit viewed from exterior.

100 Series Awning Windows (2008 to Present)

Standard and Custom Windows

Unit Sizes

100 Series Awning Warranty Label

Note:

Every 100 Series Awning Window has a permanent label containing a unique identification number. The product ID number may be 5 to 9 digits long, depending upon the age of the unit. On replacement parts the product ID is the set of numbers that appears before the first hyphen.

The label on an awning window is located in the head.

When ordering replacement parts, please provide the product ID to ensure that replacement parts match the specifications of the original product.

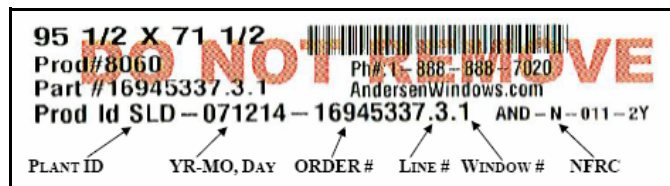

Sash

Sash																			
	<p>Note: Replacement sash for standard windows are made to order. Order replacement stationary sash for units made after 7/23/2010.</p> <p>Exterior color options: White, Sandtone, Terratone®, Cocoa Bean, Dark Bronze</p> <p>Interior finish options: Prefinished Interior White</p> <p>Glass options: Twelve (12) primary glazings</p> <table border="1"> <tr> <td>Low -E</td> <td>Low-E Tempered</td> <td>Low-E Obscure</td> <td>Low-E Tempered Obscure</td> </tr> <tr> <td>SmartSun™</td> <td>SmartSun™ Tempered</td> <td>SmartSun™ Obscure</td> <td>SmartSun™ Tempered Obscure</td> </tr> <tr> <td>Clear Dual Pane</td> <td>Clear Tempered</td> <td>Clear Obscure</td> <td>Clear Tempered Obscure</td> </tr> </table> <p>Each of the above glazings are also available in an STC upgrade package.</p> <p>Finelight™ Grille options: Six (6) primary grille options</p> <table border="1"> <tr> <td>Colonial</td> <td>Modified Colonial</td> <td>Prairie A</td> </tr> <tr> <td>Specified Equal Lite</td> <td>Short Fractional</td> <td>Tall Fractional</td> </tr> </table> <p><i>To order, state:</i></p> <ol style="list-style-type: none"> Generic order #9000405 Warranty label ID # (see warranty label page 5) Manufacturing date and product description 	Low -E	Low-E Tempered	Low-E Obscure	Low-E Tempered Obscure	SmartSun™	SmartSun™ Tempered	SmartSun™ Obscure	SmartSun™ Tempered Obscure	Clear Dual Pane	Clear Tempered	Clear Obscure	Clear Tempered Obscure	Colonial	Modified Colonial	Prairie A	Specified Equal Lite	Short Fractional	Tall Fractional
Low -E	Low-E Tempered	Low-E Obscure	Low-E Tempered Obscure																
SmartSun™	SmartSun™ Tempered	SmartSun™ Obscure	SmartSun™ Tempered Obscure																
Clear Dual Pane	Clear Tempered	Clear Obscure	Clear Tempered Obscure																
Colonial	Modified Colonial	Prairie A																	
Specified Equal Lite	Short Fractional	Tall Fractional																	

Glass Only																			
	<p>Note: Order replacement glass for stationary units made prior to 7/23/2010. Glass ships with glazing bead and silicone.</p> <p>Glass options: Twelve (12) primary glazings</p> <table border="1"> <tr> <td>Low-E</td> <td>Low-E Tempered</td> <td>Low-E Obscure</td> <td>Low-E Tempered Obscure</td> </tr> <tr> <td>SmartSun™</td> <td>SmartSun™ Tempered</td> <td>SmartSun™ Obscure</td> <td>SmartSun™ Tempered Obscure</td> </tr> <tr> <td>Clear Dual Pane</td> <td>Clear Tempered</td> <td>Clear Obscure</td> <td>Clear Tempered Obscure</td> </tr> </table> <p>Each of the above glazings are also available in an STC upgrade package.</p> <p>Finelight Grille options: Six (6) primary grille options</p> <table border="1"> <tr> <td>Colonial</td> <td>Modified Colonial</td> <td>Prairie A</td> </tr> <tr> <td>Specified Equal Lite</td> <td>Short Fractional</td> <td>Tall Fractional</td> </tr> </table> <p><i>To order, state:</i></p> <ol style="list-style-type: none"> Generic order #9000405 Warranty label ID # (see warranty label page 5) Manufacturing date and product description 	Low-E	Low-E Tempered	Low-E Obscure	Low-E Tempered Obscure	SmartSun™	SmartSun™ Tempered	SmartSun™ Obscure	SmartSun™ Tempered Obscure	Clear Dual Pane	Clear Tempered	Clear Obscure	Clear Tempered Obscure	Colonial	Modified Colonial	Prairie A	Specified Equal Lite	Short Fractional	Tall Fractional
Low-E	Low-E Tempered	Low-E Obscure	Low-E Tempered Obscure																
SmartSun™	SmartSun™ Tempered	SmartSun™ Obscure	SmartSun™ Tempered Obscure																
Clear Dual Pane	Clear Tempered	Clear Obscure	Clear Tempered Obscure																
Colonial	Modified Colonial	Prairie A																	
Specified Equal Lite	Short Fractional	Tall Fractional																	

100 Series Awning Windows (2008 to Present)

Standard and Custom Windows

Sash

Glazing Beads

Glazing Bead



Note:

Replacement glazing beads are made to order.

To order, state:

1. Generic order #9000405
2. Warranty label ID # (see warranty label [page 5](#))
3. Manufacturing date and product description

Setting Block

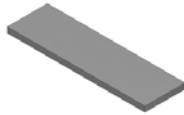

Note:

Quantity of eight.

Dimensions

1/8" x 7/8" x 3"

**Silver Line
Order No.**

34-1022A-1

**Andersen
Order No.**

9046289

Sash Weatherstrip

Sash Weatherstrip - Bulb

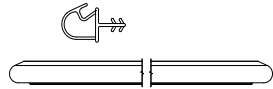

Description

Note:

Comes as 72" length.

Order No.

22-2312-6

Sash Weatherstrip - Leaf

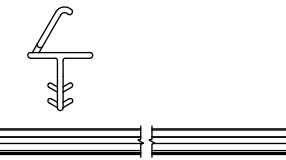

Description

Note:

Comes as 69 1/2" length.

Order No.

22-2311-69

Insect Screen

Insect Screen

Insect Screen Assembly

**Note:**

Replacement screens are made to order.

To order, state:

1. **Generic order #9000405**
2. **Warranty label ID # (see warranty label [page 5](#))**
3. **Manufacturing date and product description**

100 Series Awning Windows (2008 to Present)

Standard and Custom Windows

Hardware

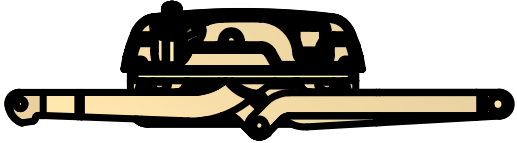
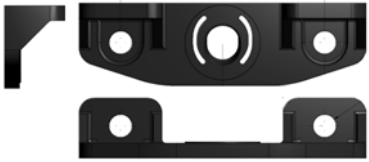
Operators		
Operator - Encore / Low Profile		
		Order No.
		07-51-11-00-011
		Corrosion Resistant
		07-51-11-00-521
Operator - Sash Bracket		
	Note: Attaches to bottom of awning sash.	Order No.
		07-22143

Hinge Kits		
Note: Handing as follows: RH unit (viewed from exterior hinge side) uses RH hinge kit for sill and LH hinge kit for head.		
Kit includes: 1 - Hinge track, 14"; 1 - hinge arm, 14"; and 8 - #7 x 3/4" Phil, FH Undercut SS 410 screws		
Awning Hinge Kit - 14"		
	Left	Right
	00-HK14-LH	00-HK14-RH
Awning Hinge Kit - 14" / Corrosion Resistant		
	Left	Right
	00-HCR14-LH	00-HCR14-RH

Hardware

Handle Parts

Cover - Tango Operator		
		Order No.
		07-45454-40-1055

Handle - Tango

		Order No.
		07-12613-40-1055

Lock Components

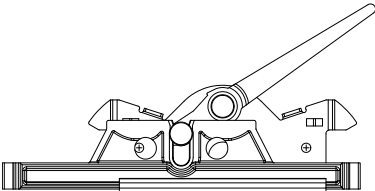
Lock Drive		
		Order No.
		07-12871-92

Lock Handle

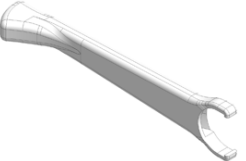
		Order No.
		07-41599-40-1055

100 Series Awning Windows (2008 to Present)

Standard and Custom Windows

Hardware

Lock Bezel		
		Order No.
		07-41393-40-1055

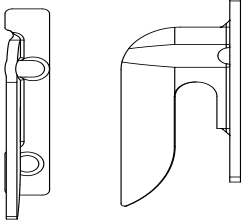
Lock Keeper			
	Note: Handing is determined as viewed from the exterior.	Left	Right
		07-33593-92	07-33592-92
Lock Keeper - Corrosion Resistant			
		Left	Right
		07-33593-00-0500	07-33592-00-0500

Hardware

Lock-Bar - 7"				
	Regular		Corrosion Resistant	
	Left	Right	Left	Right
	07-14009-92	07-14010-92	07-14009	07-14010



Fasteners

Screw - Installation			
	Description	Order No.	
	#8 x 3" Bugle Head, Coarse Thread Note: Use for installation of casement, awning and fixed products.	109-00-083003	
Screw			
	Description	Standard	HCR
	#6 x 5/8" Flat Hd Sheet Metal Type A Zinc Note: Quantity of four. Use to secure keeper.	109-00-0606254	109-HCR-00-0606255
Screw			
	Description	Standard	HCR
	#6 x 5/8" Pan Hd Sheet Metal Type A Zinc Note: Quantity of four. Use to install lock drive and tie bars.	109-00-0606253	109-HCR-00-0606256
Screw			
	Description	Standard	HCR
	#7 x 3/4" Flat Hd Undercut Sheet 410 SS Type A 18-8 Note: Quantity of four. to: Use to secure hinge track, hinge arms, operator track, stationary bracket, stationary spacer, and snubbers used after 07/2010.	109-00-19101	109-HCR-00-070751
Screw			
	Description	Standard	HCR
	#8 x 5/8" Flat Hd Sheet Metal Type A Zinc Note: Quantity of four. Use to install operator and stud bracket.	109-00-0807510	109-HCR-00-080754
Screw			
	Description	Standard	HCR
	#8 x 5/8" Pan Hd Sheet Metal Type A Zinc. Note: Quantity of four. Use to secure snubbers used prior to 07/2010 and current awning operator bracket.	109-00-08062533	09-HCR-00-08062532

100 Series Awning Windows (2008 to Present)

Standard and Custom Windows

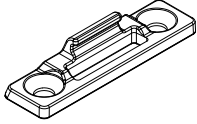
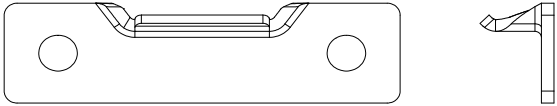
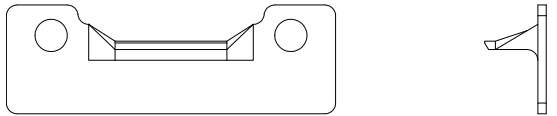
Hardware

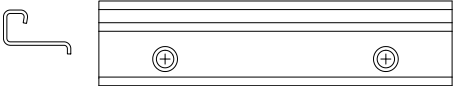
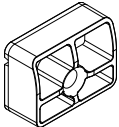
Hardware Parts			
Snubber (7/2010 to Present)			
		Order No.	
		07-CA20-033	
Compression Snubber - Sash (Prior to 7/2010)			
		Order No.	
		31496-00-0500	
Compression Snubber - Frame (Prior to 7/2010)			
		Order No.	
		32939-00-0500	
Stationary Clip			
		Order No.	
		07-1265A	
Stationary Bracket			
		Order No.	
		07-1264A	
Spacer - Stationary Sash			
		Color	Order No.
		White	07-1066A-AWHT
		Black	07-1066A-BLK
		Sandtone	07-1066A-SND

Frames

Frame Assembly

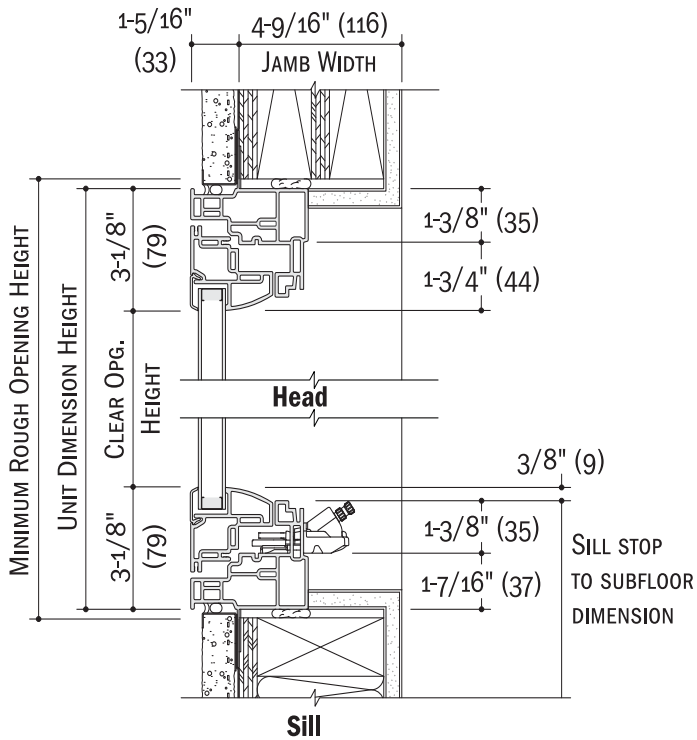

Vertical Section
Casement or Awning Window

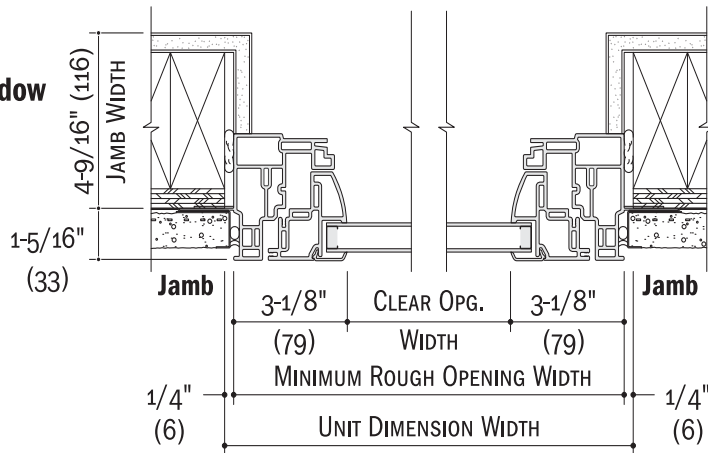

Horizontal Section
Casement or Awning Window

100 Series Awning Window Frame Assembly

100 Series Awning Windows (2008 to Present)

Standard and Custom Windows

Frames

Frames	
Frame	
Note: Replacement frames are not available. Replace complete unit assembly.	

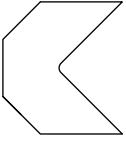
Frame Parts		
Frame Corner Gasket		
		Order No.
		34-1148A-BLK

Sloped Sill Adaptor				
		Color	48"	96"
		White	50-1028A-48-AWHT	50-1028A-96-AWHT
		Terratone®	50-1028A-48-TT	50-1028A-96-TT
		Sandtone	50-1028A-48-SND	50-1028A-96-SND
		Cocoa Bean	50-1028A-48-CCBN	50-1028A-96-CCBN
		Dark Bronze	50-1028A-48-DZ	50-1028A-96-DZ

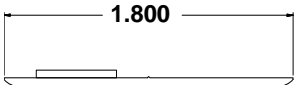
Gasket - Operator		
	Note: Sits underneath operator.	Order No.
		34-1490A
Extension Jamb Attachment Flange		
	Note: Refer to installation guide 9064334 for instructions.	Order No.
		00-PKD0783

Joining Component

Joining Components

Interior/Exterior Trim - 96" Piece

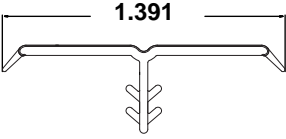
	Note: Used June 2012 to present. See page 19 for previous vintage.	Color	Order No.
		White	52-1581A-AWHT
		Terratone®	52-1581A-TT
		Sandtone	52-1581A-SND
		Cocoa Bean	52-1581A-CCBN
Dark Bronze	52-1581A-DZ		

Window Mull Accessory Kit

Kit Contains: Gusset plates, gusset plate gaskets, screws, flange gaskets and end caps.	Color	Order No.
	White	00-100SHCSPW-AWHT
	Terratone®	00-100SHCSPW-TT
	Sandtone	00-100SHCSPW-ST
	Cocoa Bean	00-100SHCSPW-CCBN
Dark Bronze	00-100SHCSPW-DZ	

End Cap

	Color	Order No.
	White	07-1515A-AWHT
	Terratone®	07-1515A-TT
	Sandtone	07-1515A-SND
	Cocoa Bean	07-1515A-CCBN
Dark Bronze	07-1515A-DZ	

Head Flashing - Universal Drip Cap / 95.5" Piece

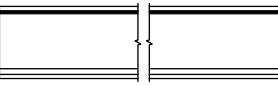
	Color	Order No.
	White	50-1056A-AWHT
	Terratone®	50-1056A-TT
	Sandtone	50-1056A-SND
	Cocoa Bean	50-1056A-CCBN
Dark Bronze	50-1056A-DZ	

100 Series Awning Windows (2008 to Present)

Standard and Custom Windows

Joining Component

Head flashing - Universal Drip Cap / 95.5 / 1" Stucco Key Frame			
		Color	Order No.
		White	50-1050A-1AWHT
		Terratone®	50-1050A-1TT
		Sandtone	50-1050A-1SND
		Cocoa Bean	50-1050A-1CCBN
Dark Bronze	50-1050A-1DZ		

Screw - Joining			
		Description	Order No.
		#8 x 2 3/4" Bugle Head	00-0827501
		#8 x 2" Bugle Head HD	00-082080-AWHT
		#8 x 3/4" Pan Head	00-0807551

Gasket - Nailing Flange		
		Order No.
		34-1179A-BLK

Gasket - Gusset Plate		
		Order No.
		34-1060A

Gusset Plate		
		Order No.
		51-5211

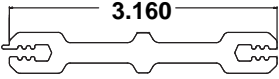
Fiberglass Joining Strip - 95" Piece		
		Order No.
		46-1519A

Notes

100 Series Awning Windows (2008 to Present)

Service Replacement

Service Replacement Only Parts

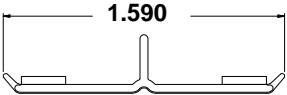
Trim Strip			
Interior/Exterior Trim with VHB Tape Applied - 96" Piece			
	Note: Used through May 2012.	Color	Order No.
		White	52-1047AWHT
		Terratone®	52-1047ATT
		Sandtone	52-1047ASND
		Cocoa Bean	52-1047ACCBN
		Dark Bronze	52-1047DZ

Notes
